

翼（主翼・垂直尾翼・水平尾翼）

主翼（左）

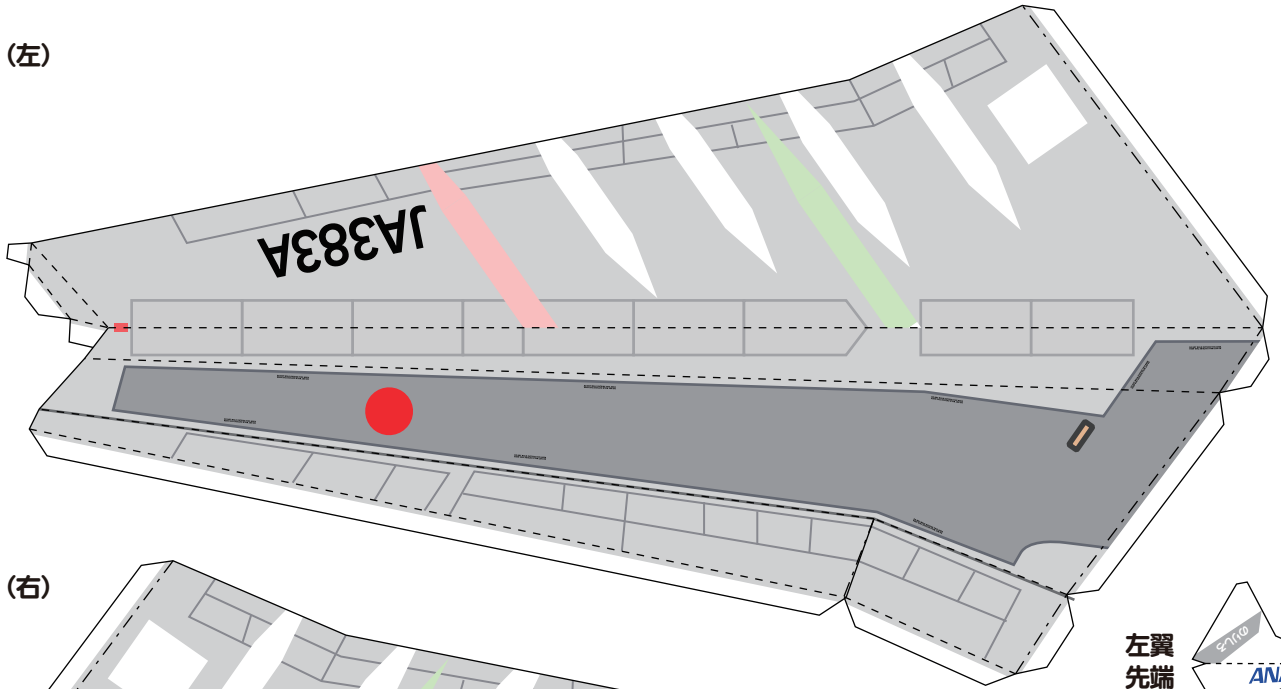

主翼（右）

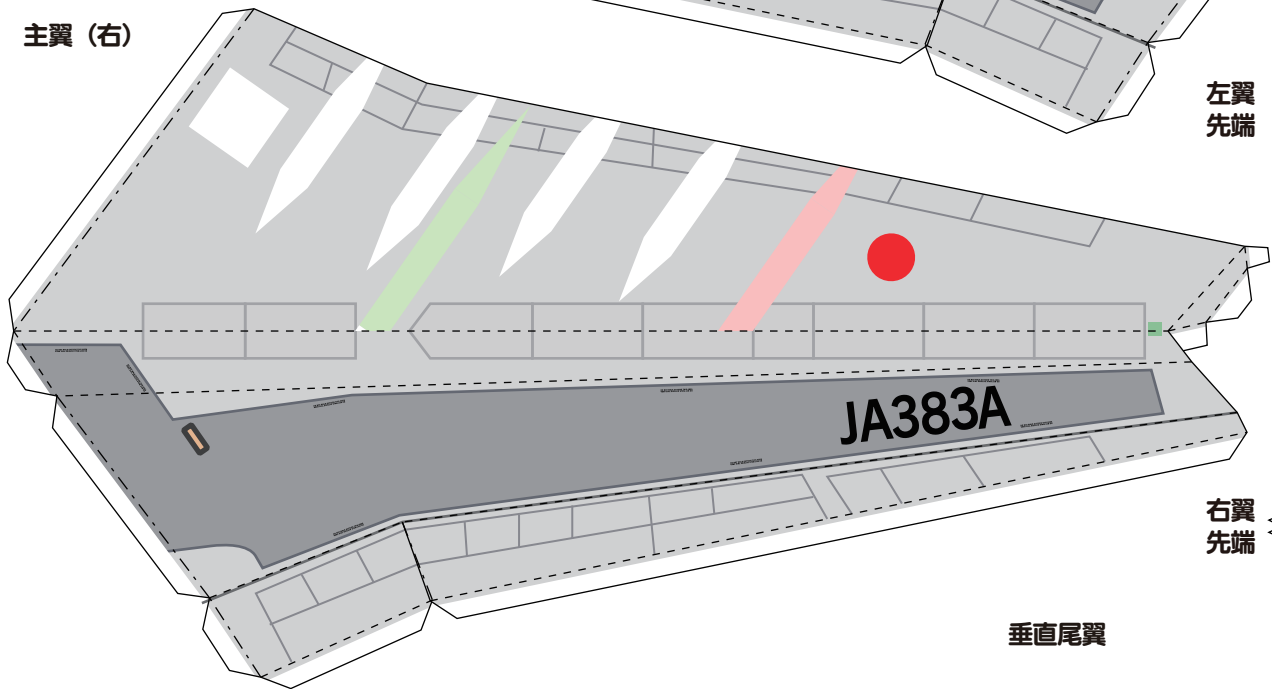

左翼
先端

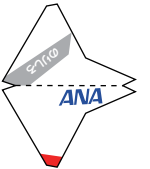

右翼
先端

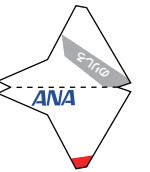

垂直尾翼

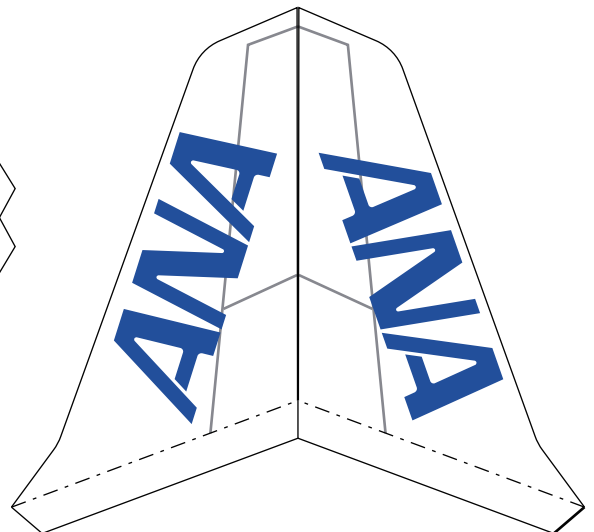

水平尾翼

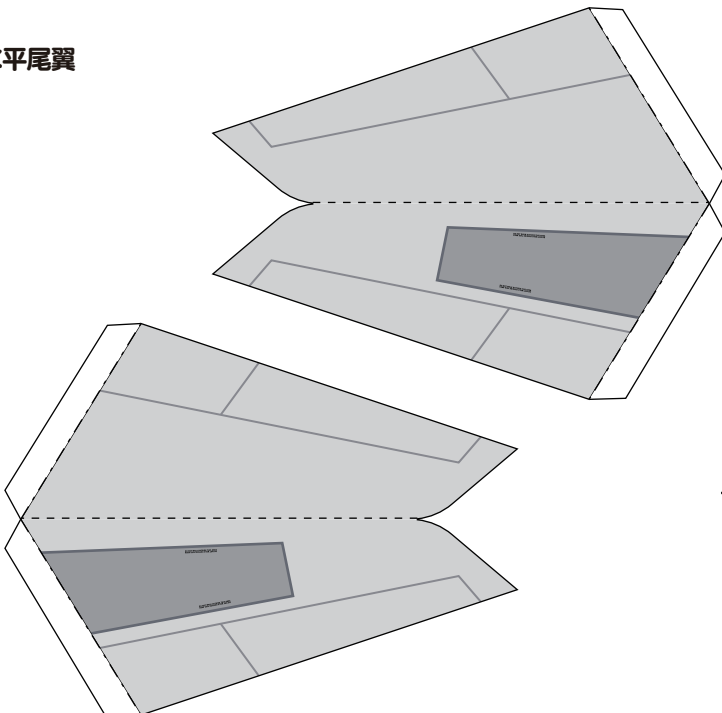

----- 山折り
- - - - - 谷折り

エンジンまわり

エンジン 支え

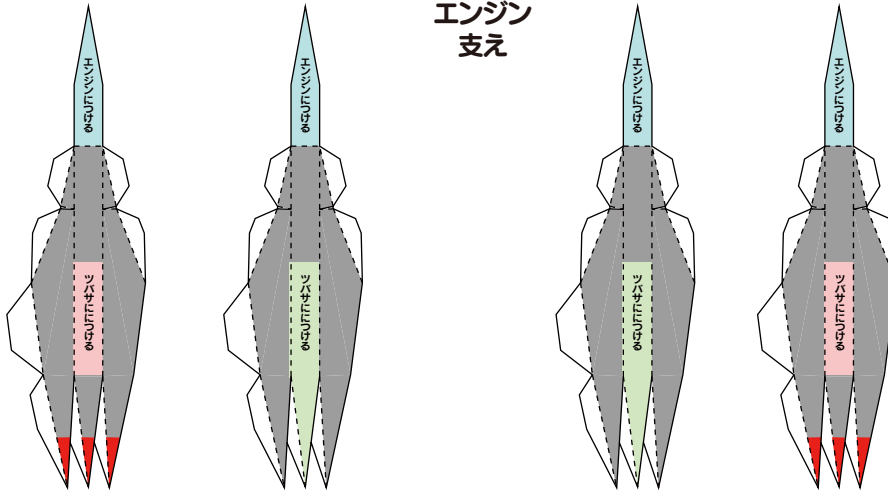

エンジン左翼 (のりしろが上になる)

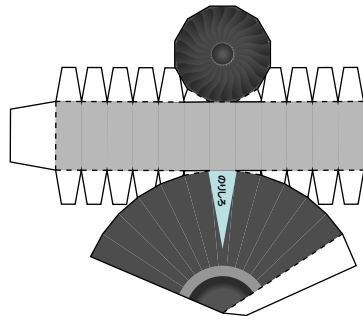
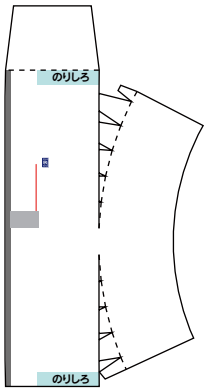

エンジン右翼 (のりしろが上になる)

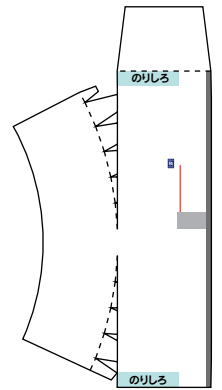
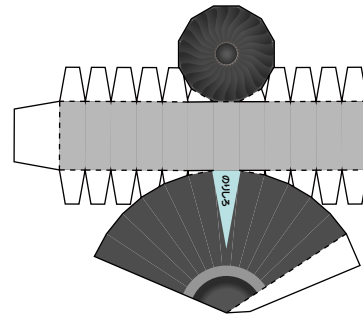
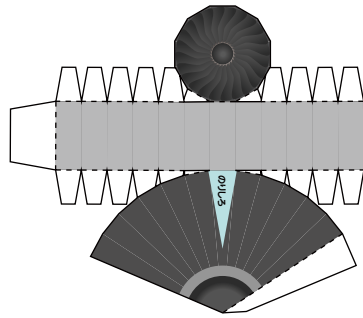
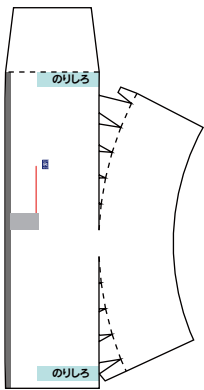
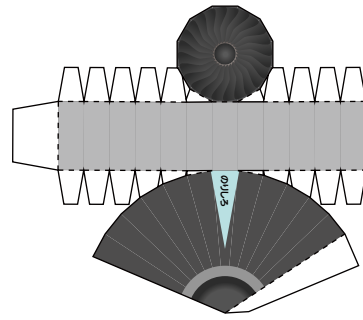
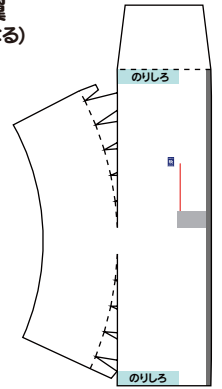

フェアリング

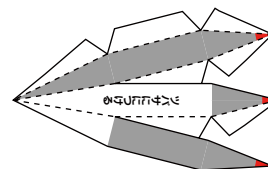
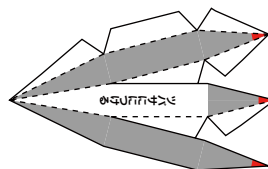
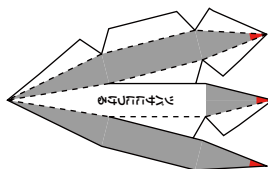
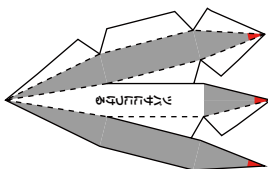
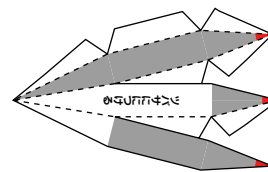
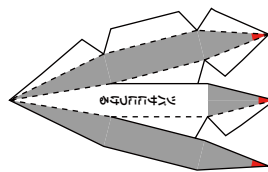
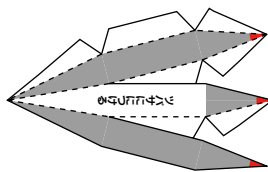
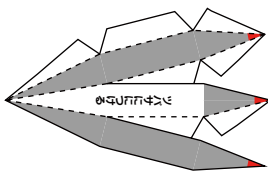

胴体 (サンセットオレンジ)

コックピット

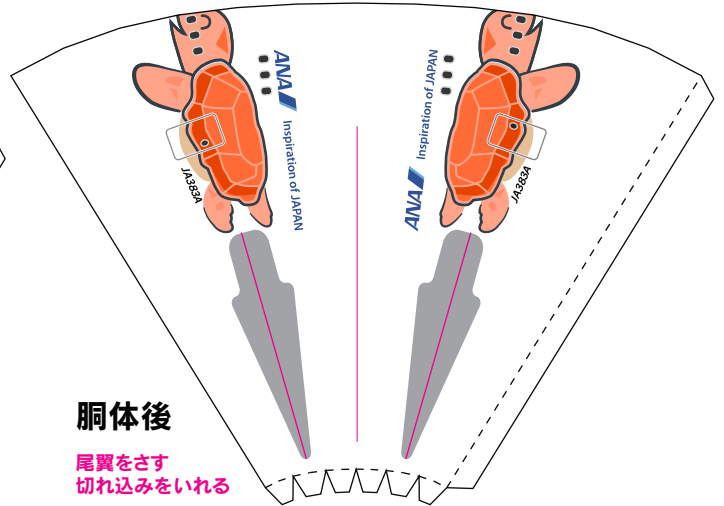
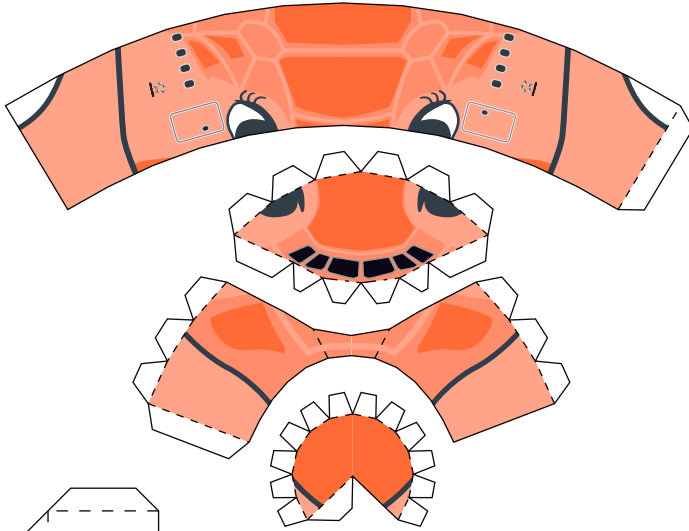

胴体後

尾翼をさす
切れ込みをいれる

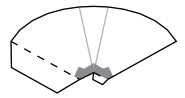

胴体上

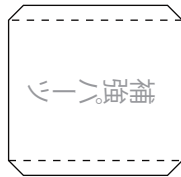
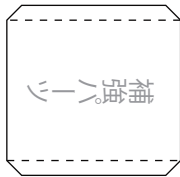
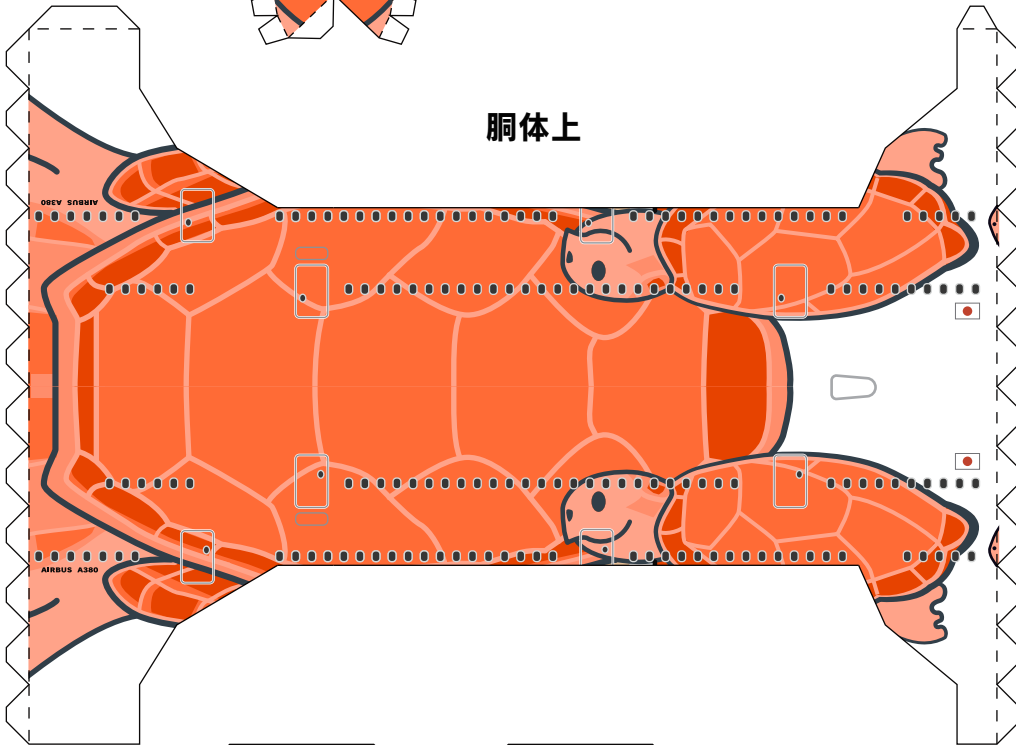

胴体下の補強パーツ

胴体下

